

System «Optima»

New development company RIAL.PRO

Lower support system "Optima" with the possibility of combining filling 4mm and 10mm made according to new trends in the market with the minimum visible part of aluminum (10mm)



Principle of construction

Frame
System

Filling

10mm
4mm

Maximum
door weight

55 kg

Maximum
door height

2,7m

Maximum
door width

1,2m

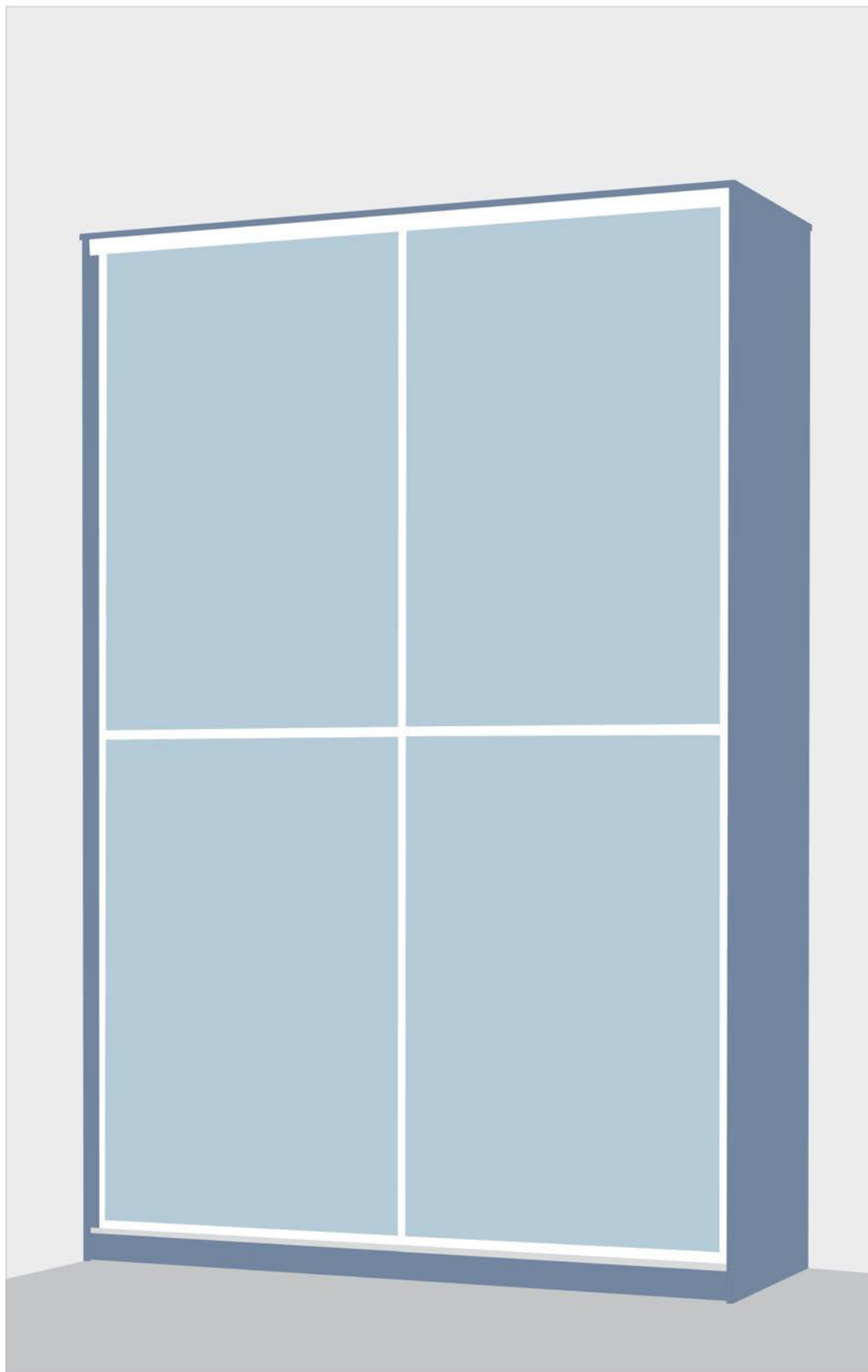

System Composition

KO-01

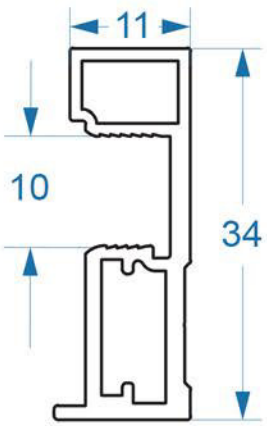

KR-02

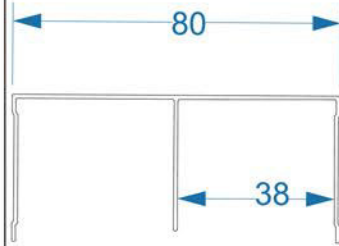

KR-05

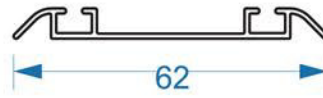

KO-07

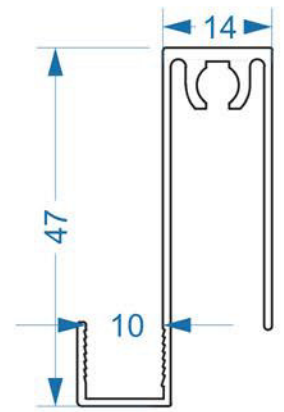

KO-08

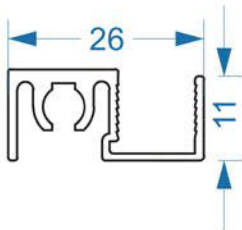

KO-09

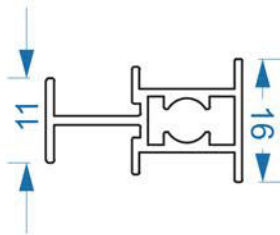

KR10B/11B

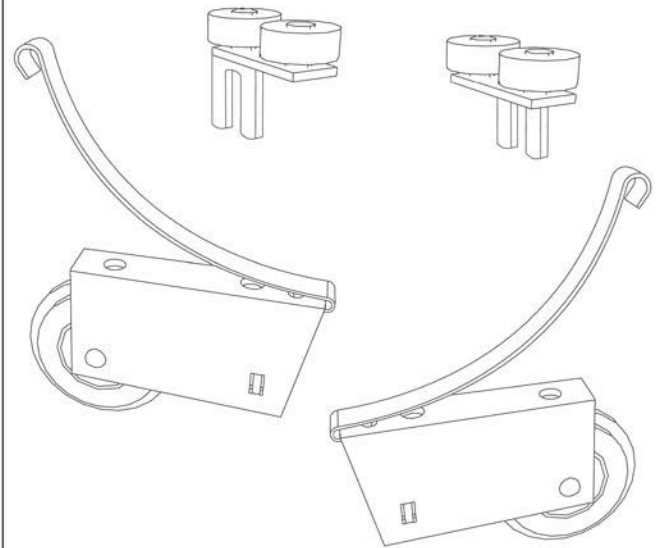

KO-01 - Handle profile

KR-02 - Top guide profile

KR-05 - Lower running profile

KO-07 - Lower profile frame

KO-08 - Top frame profile

KO-09 - Divider

KR10B/11B - Wheels